

## SISTEMA DE SEÑALIZACIÓN

Sistemas de señalización a pared. No es necesario realizar taladro en el panel de gráfica. Permite el cambio de gráfica fácilmente.

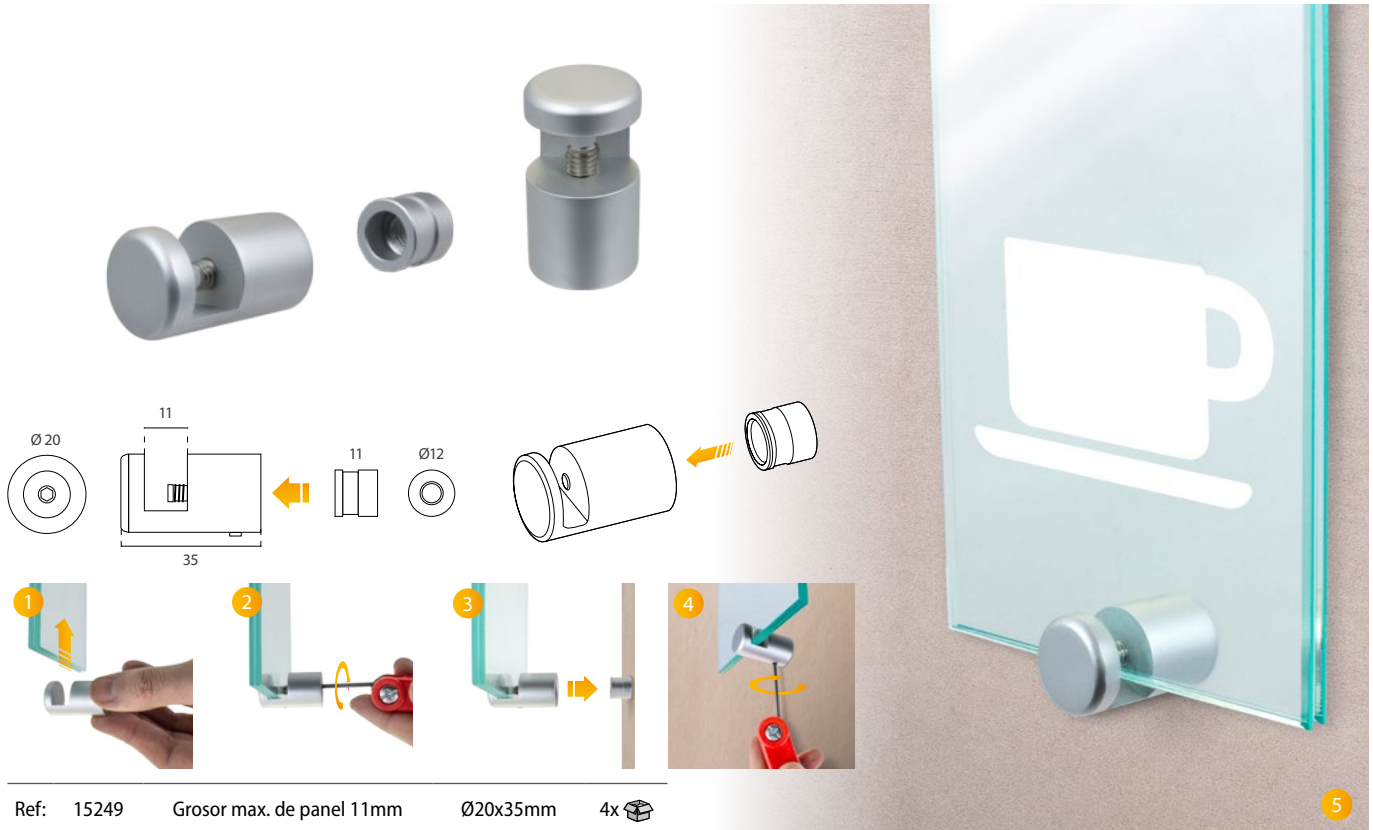

Ref: 15249 Grosor max. de panel 11mm Ø20x35mm 4x

## SISTEMA DE SOBREMESA CON SOPORTE

Sistema compuesto de 2 piezas de acero que permiten la colocación de un cartel sobre un escritorio a modo identificativo o informativo. Se suministran en bolsas de 2 unidades. Uso interior en escritorios, recepciones, mostradores, etc. Fácil y rápido montaje. Materiales recomendados: metacrilato, PS, placas de aluminio, etc. Placas y gráficas no incluidas.

Contenido: 2 piezas de acero cromado.

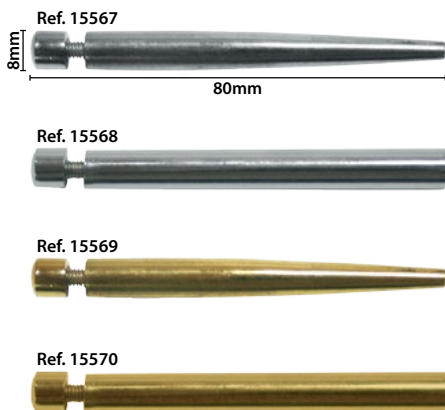

Ref: 15567	Ø8x80mm		2x
Ref: 15568	Ø8x80mm		2x
Ref: 15569	Ø8x80mm		2x
Ref: 15570	Ø8x80mm		2x

## SEPARADORES-EMBELLECEDORES

Sistema de fijación a pared de cartelería mediante dos piezas de acero que permiten aislarlo de la pared y a su vez proteger los tornillos utilizados para darle un mejor acabado. Disponible en color dorado y cromado en varias medidas. Se suministran packs de 4 unidades. Uso en interior y exterior, en placas de diferentes tipos, materiales y tamaños.



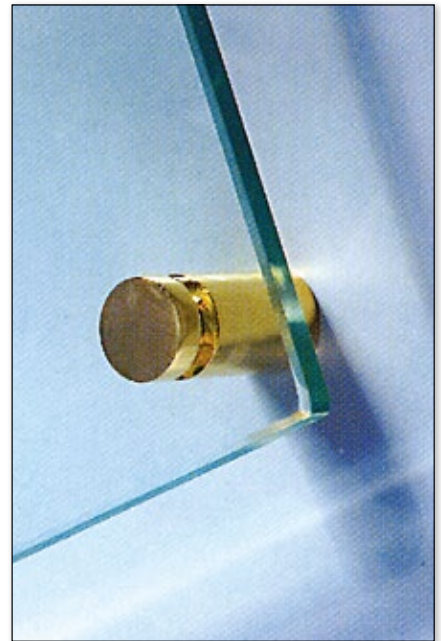



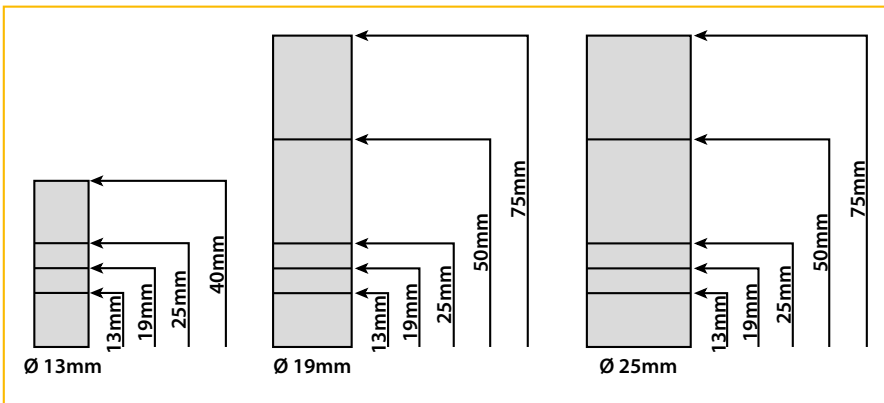

Contenido: separador y embellecedor.











### Tamaños

























### Diámetro 13mm

	Ref: 15500	13x13mm		4x 
	Ref: 15501	13x19mm		4x 
	Ref: 15502	13x25mm		4x 
	Ref: 15503	13x40mm		4x 











	Ref: 15504	13x13mm		4x 
	Ref: 15505	13x19mm		4x 
	Ref: 15506	13x25mm		4x 
	Ref: 15507	13x40mm		4x 











### Diámetro 19mm

	Ref: 15508	19x13mm		4x 
	Ref: 15509	19x19mm		4x 
	Ref: 15510	19x25mm		4x 
	Ref: 15511	19x50mm		4x 
	Ref: 15512	19x75mm		4x 

	Ref: 15513	19x13mm		4x 
	Ref: 15514	19x19mm		4x 
	Ref: 15515	19x25mm		4x 
	Ref: 15516	19x50mm		4x 
	Ref: 15517	19x75mm		4x 

### Diámetro 25mm

	Ref: 15518	25x13mm		4x 
	Ref: 15519	25x19mm		4x 
	Ref: 15520	25x25mm		4x 
	Ref: 15521	25x50mm		4x 
	Ref: 15522	25x75mm		4x 

	Ref: 15523	25x13mm		4x 
	Ref: 15524	25x19mm		4x 
	Ref: 15525	25x25mm		4x 
	Ref: 15526	25x50mm		4x 
	Ref: 15527	25x75mm		4x 

## SEPARADORES-EMBELLECEDORES

Sistema de fijación a pared de cartelería mediante dos piezas de acero que permiten aislarlo de la pared y a su vez proteger los tornillos utilizados para darle un mejor acabado. Disponible en varios colores y medidas. Se suministran packs de 4 unidades. Uso en interior y exterior, en placas de diferentes tipos, materiales y tamaños.

Contenido: separador y embellecedor.



### Diámetro 13mm

Ref: 15528	13x13mm	■	4x
Ref: 15532	13x13mm	■	4x
Ref: 15536	13x13mm	■	4x
Ref: 15540	13x13mm	■	4x

Ref: 15529	13x19mm	■	4x
Ref: 15533	13x19mm	■	4x
Ref: 15537	13x19mm	■	4x
Ref: 15541	13x19mm	■	4x

### Diámetro 19mm

Ref: 15530	19x25mm	■	4x
Ref: 15534	19x25mm	■	4x
Ref: 15538	19x25mm	■	4x
Ref: 15542	19x25mm	■	4x

### Diámetro 25mm

Ref: 15531	25x30mm	■	4x
Ref: 15535	25x30mm	■	4x
Ref: 15539	25x30mm	■	4x
Ref: 15543	25x30mm	■	4x



## EMBELLECEDORES

Sistema que consiste en colocar unas anillas y embellecedores sobre las cabezas de los tornillos que quedan al descubierto para taparlos. Disponible en cromado y dorado. Se suministran packs de 4 unidades. Uso en interior y exterior, sobre placas de metacrilato u otros materiales a pared.

Contenido: separador y embellecedor.

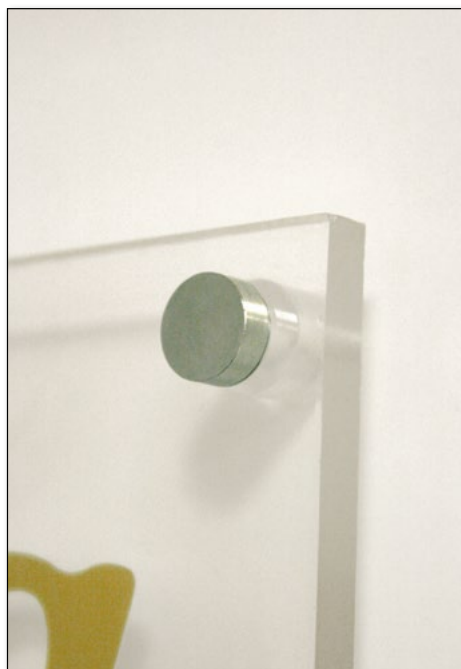
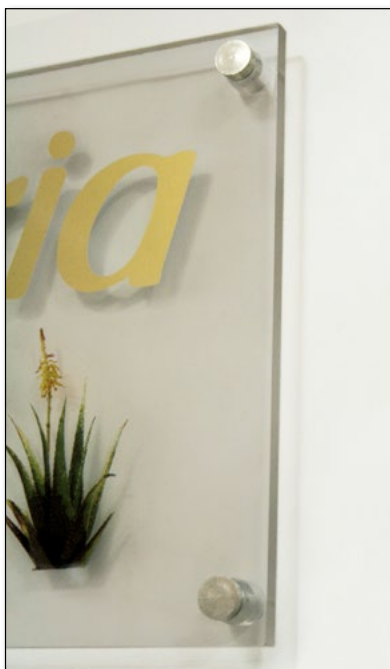

Ref: 15544	15mm	■	4x
Ref: 15545	19mm	■	4x
Ref: 15546	25mm	■	4x







Ref: 15547	15mm	■	4x
Ref: 15548	19mm	■	4x
Ref: 15549	25mm	■	4x





## SEPARADOR

Sistema de separación de cartelería, que permite fijar en su interior materiales de 8 a 10mm de espesor. Disponible en dorado y cromado en varias medidas. Se suministran packs de 4 unidades. Uso en interior con metacrilatos, cristales, etc.

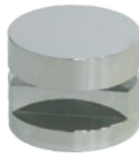
Contenido: 2 piezas (separadores).

Ref: 15550	20x25mm		4x 
Ref: 15551	20x30mm		4x 



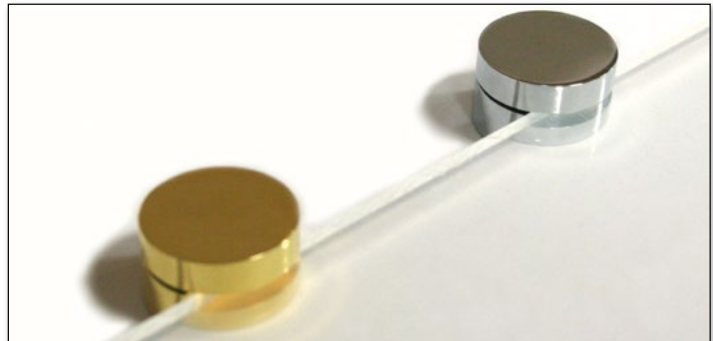
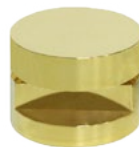

Ref: 15552	20x25mm		4x 
Ref: 15553	20x30mm		4x 





## SEPARADOR CUADRADO

Sistema de separación de cartelería, permite fijar en su interior materiales de hasta 10mm de espesor. Disponible en dorado y cromado. Se suministran packs de 4 unidades. Uso en interior con metacrilatos, cristales, etc.

Contenido: 2 piezas (separadores).

Ref: 15565	25x25mm		4x 
------------	---------	---	--



Ref: 15564	25x25mm		4x 
------------	---------	---	--

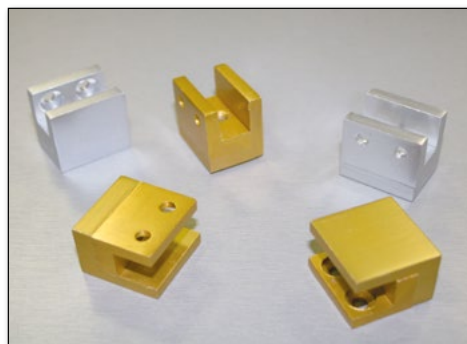

## SUJETA ESTANTES



Sistema de sujeción de estanterías o cartelería mediante unas piezas de acero atornilladas a la pared. Disponible en dorado y cromado. Varios modelos a elegir. Uso para fijación de baldas en locales, tiendas, cartelería, etc.

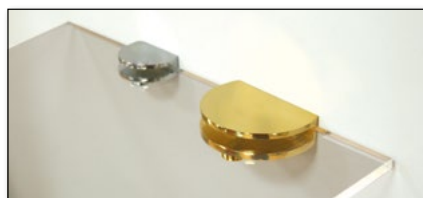
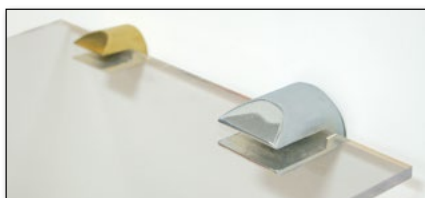

Contenido: 1 pieza (sujeta estante).



Ref: 15558	35x35mm	Espesor 12mm		4x 
------------	---------	--------------	---	--

Ref: 15560	25x25mm	Espesor 9,5mm		4x 
------------	---------	---------------	---	--

Ref: 15559	35x35mm	Espesor 12mm		4x 
------------	---------	--------------	---	--



Ref: 15561	25x25mm	Espesor 9,5mm		4x 
------------	---------	---------------	---	--





15554



15557

Ref: 15554	30mm	Espesor 7,5mm		2x 
------------	------	---------------	---	--

Ref: 15555	50mm	Espesor 9,5mm		2x 
------------	------	---------------	---	--

Ref: 15556	30mm	Espesor 7,5mm		2x 
------------	------	---------------	---	--



Ref: 15557	50mm	Espesor 9,5mm		2x 
------------	------	---------------	---	--



15563



15562

Ref: 15562	80x25mm	Espesor 12mm		4x 
------------	---------	--------------	---	--

Ref: 15563	50x25mm	Espesor 10mm		4x 
------------	---------	--------------	---	--